

HSE ROHS

SPECIFICATIONS

Rated Current:5.0AMP
 Voltage rating:250V AC,DC
 Contact Resistance:20mΩ Max
 Withstand Voltage:1500V AC/Minute
 Insulation Resistance:1000MΩ Min
 Operation Temperature:-40°C to +105°C

Contact Material:Brass
 Contact Plating:Tin Over Ni
 Solder Tabs Material:Brass / Tin-plated
 Insulator Material:Polyester(ULE94V-0)
 Standard: PA6T
 Max.Processing Temp: 230°C for 30-60 seconds
 (260°C for 10 seconds)

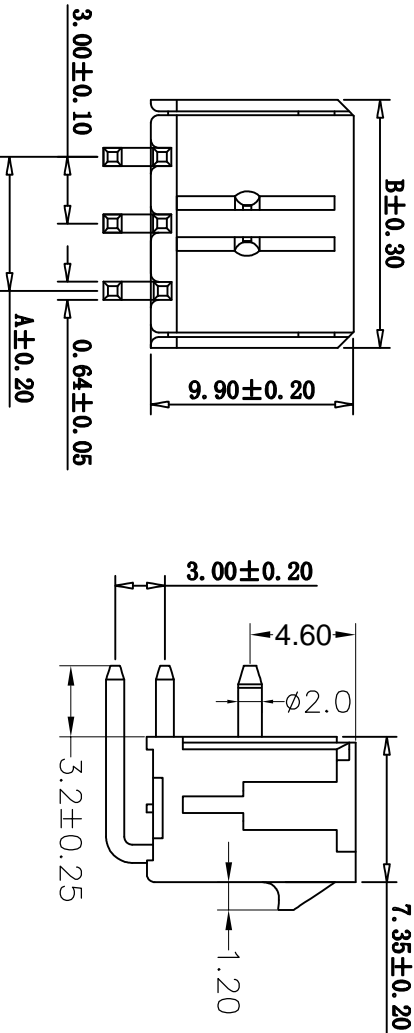
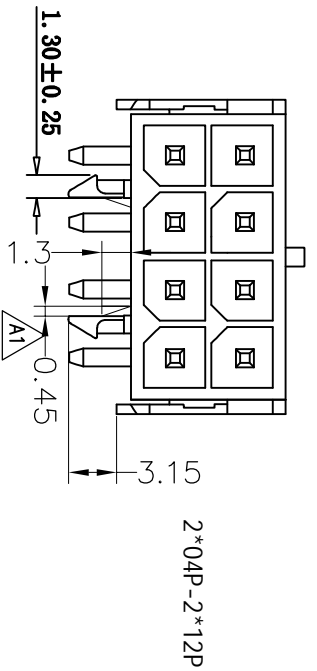
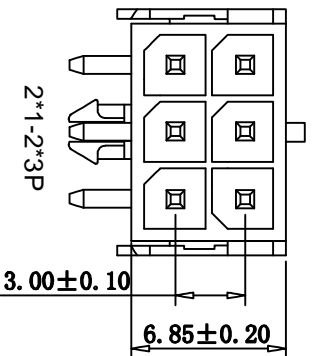

Circuit	Dimension	
	A	B
02	---	6.65
04	3.00	9.65
06	6.00	12.65
08	9.00	15.65
10	12.00	18.65
12	15.00	21.65
14	18.00	24.65
16	21.00	27.65
18	24.00	30.65
20	27.00	33.65
22	30.00	36.65
24	33.00	39.65

Ordering Information

JL 3001 R - 2 XX X XX B X 01

No. of Pins: 2~24P
 Insulator Material Option: C=BK-PA6T, E=BK-PA9T, F=BK-LCP
 Contact Plating: G=Gold Flash, S=Gold Flash/Tin, SN: Tin, SM: Matte-Tin
 Packing: O=Pe bag, T=tube, R=Reel

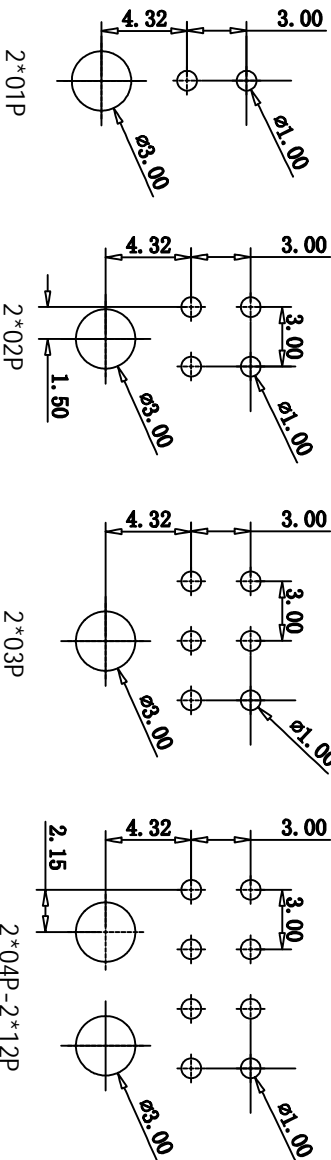

P. C. B. LAYOUT

REV	DATE	MODIFICATION DESCRIPTION	CHANGE	OPERATION		DRAW	chengyigang	19.11.05	SCALE		FIT	TITLE:	
				X.X	±0.30				UNIT	mm		PART NO.	MX3.00mm Wafer Npin 90° DIP
A1	2019.11.05	改模后加三角形		X.XX	±0.20	CHECK			A4			JL3001R-2XXXXXB01	
A0	2012.05.22	NEW DRAWING		X.XXX	±0.10	CHECK			1/2				
1						APPROVE							

JIN 深圳市锦凌电子有限公司
 SHENZHEN JINLING ELECTRONIC CO.,LTD
 Tel: 86-755-2997-5806/5802 Fax: 86-755-2997-5992

A	REV	DATE	MODIFICATION DESCRIPTION	CHANGE	OPERATION	DRAW	SCALE	FIT	PART NO.	TITLE:	JL3001R-2XXXXXXBX01	MX3.0mm Water Npin 90° DIP	
A1	2019.11.05	2012.05.22	改模后加三角形	NEW DRAWING	X.XX X:XX X:XXX Angle	chengyigong	±0.30 ±0.20 ±0.10	A4	Tel: 86-755-2997-5806/5802	深圳市锦凌电子有限公司	Fax: 86-755-2997-5992		
1	2	3	4	5	6	7	8	9					

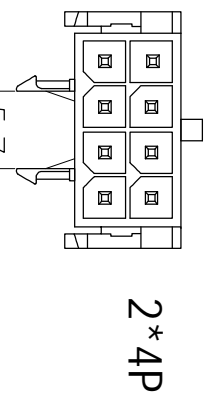
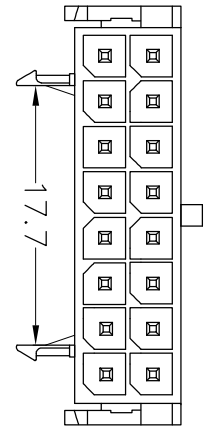
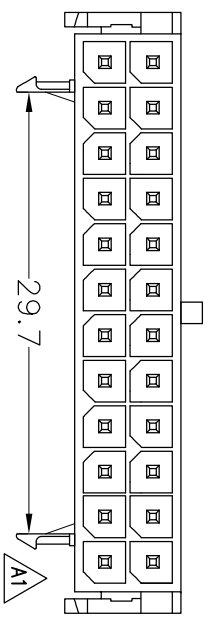

2*12P

2*8P

2*4P

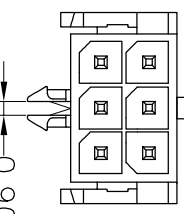
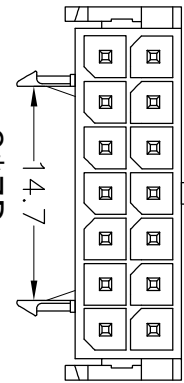
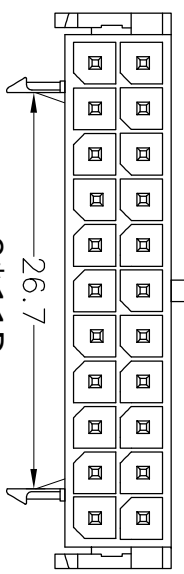

2*11P

2*7P

2*3P

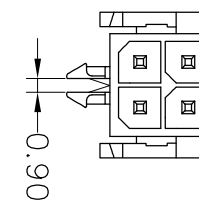
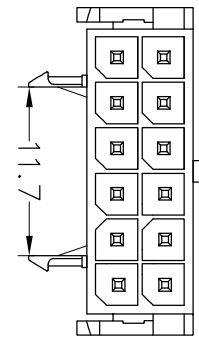
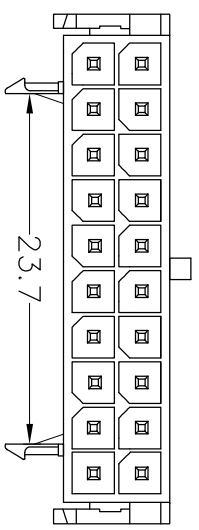

2*10P

2*6P

2*2P

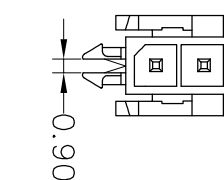
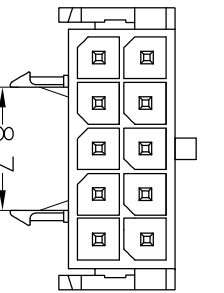
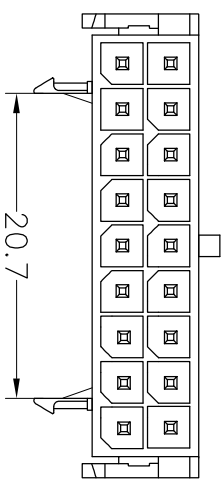

2*9P

2*5P

2*1P